

Rittal – The System.

Faster – better – everywhere.

► Efficient Liquid Cooling



ENCLOSURES POWER DISTRIBUTION CLIMATE CONTROL IT INFRASTRUCTURE SOFTWARE & SERVICES



Rittal – The System.

Faster – better – everywhere.



ENCLOSURES

POWER DISTRIBUTION

CLIMATE CONTROL

FRIEDHELM LOH GROUP

Contents

Overview

Rittal liquid cooling is a particularly efficient choice for these industries..... 4

Applications

Convincing cooling concepts for virtually any application.... 6

Rittal TopTherm chillers

TopTherm chillers – reliable and efficient 8
Overview of TopTherm chillers, 1 – 40 kW 10
Overview of chillers for IT cooling, 15 – 500 kW 12
TopTherm chiller in a floor standing enclosure, 1 – 6 kW.... 14
TopTherm chiller, wall-mounted, 1 – 4 kW 16
TopTherm chiller in a TS enclosure, 8 – 40 kW 18
Chillers for IT cooling, 15 – 500 kW..... 20

Rittal air/water heat exchangers

Air/water heat exchangers –
Efficient and ambient air-neutral 22
Overview of air/water heat exchangers, 0.3 – 5 kW 24
Overview of air/water heat exchangers, 1.8 – 7 kW 26
Air/water heat exchangers, 1.8 – 7 kW..... 26
LCP – Liquid Cooling Package, 10 kW..... 27
Air/water heat exchangers..... 28
LCP – Liquid Cooling Package for industry..... 30
Air/water heat exchangers – Accessories 32
Chiller option packages..... 33

Performance diagrams

TopTherm chillers/chillers for IT cooling..... 34
Characteristic curves of pump, TopTherm chillers..... 35
Air/water heat exchangers..... 36

References/service

Configure and design – Always “up-to-date” 38
References 40
Service – Global availability..... 43



Rittal – The System.

Faster – better – everywhere.

Rittal liquid cooling is a particularly efficient choice for these industries

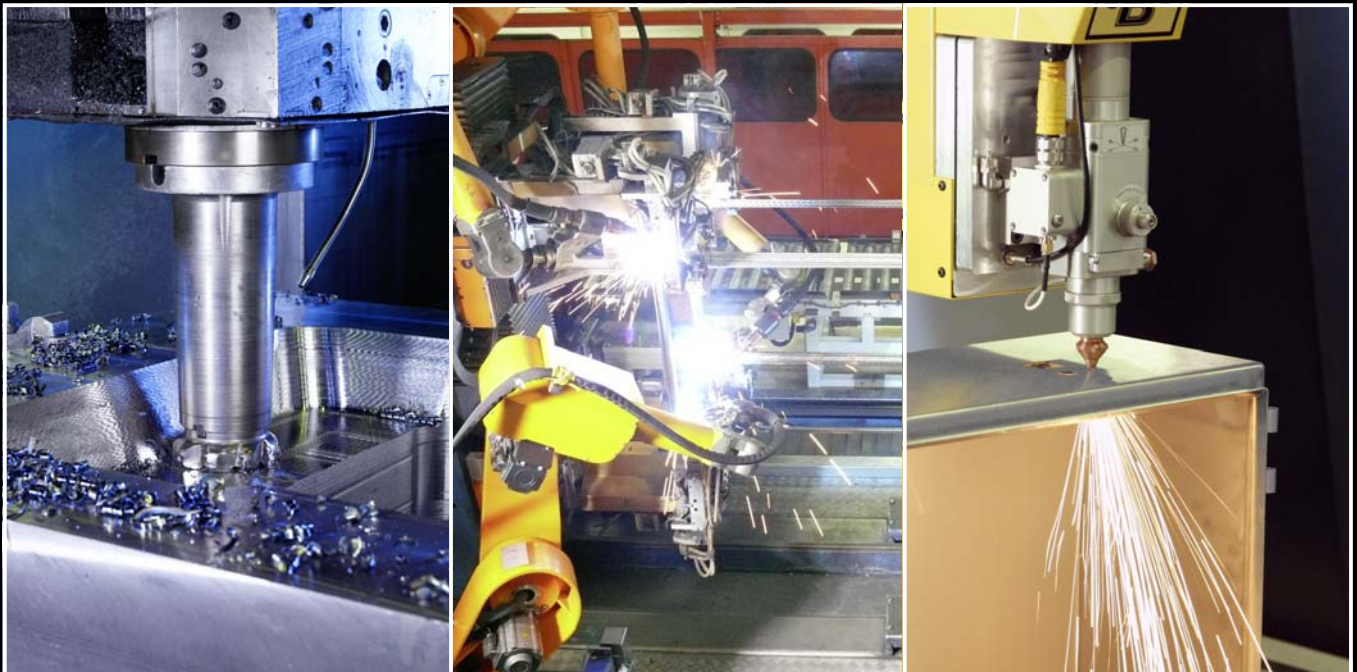

Machine tools

Application areas in this sector:
High-speed spindles, torque motors,
drive shafts, machine bed, hydraulic
aggregates and enclosures

- One version for two frequencies = international compatibility
- Energy efficiency with intelligent control
- Minimum footprint with flexible mounting system
- Approvals for the world's leading markets (GS, TÜV, UL)
- Global spare parts availability

Welding technology

Application areas in this sector:
Welded electrodes

- Integration into welding robots allows a compact design
- Nano-coated condenser ensures a high MTBF
- High energy efficiency and service life, thanks to the option of integrating into the machine control system

Laser technology

Application areas in this sector:
High-performance lasers and optics

- Innovative control concept with precise temperature hysteresis, thanks to integral PID controller
- Compact design supports a diverse range of machine integration options
- Flexibly adjustable hydraulic system
- Comprehensive package of options e.g. with adjustable pump capacity
- Pipe made from plastic, stainless steel or copper

Integral process cooling – The system for all industries

Each industry has its own requirements.

We offer an efficient, reliable process cooling solution for your specific application. Draw on our expertise accumulated in countless international projects, while at the same time capitalising on Rittal's unique system for measurable added benefits.

Take us at our word: Our expertise – your benefit.



Foods and packaging

Application areas in this sector:
Foil wrapping machines, punching stations for blister packs, and blow-moulding machines

- Stainless steel enclosures satisfy required hygiene standards
- Enhanced product safety
- Water-carrying parts made from stainless steel
- Nano-coated condenser ensures a high MTBF

Electronics/power distribution

Application areas in this sector:
Enclosures, frequency converters, generators, high-performance motors, measurement systems

- Broad cooling output spectrum from 0.3 to 10 kW
- Extensive choice of water connection options
- High level of reliability, thanks to leak monitoring
- Cooling at high ambient temperatures up to +70°C
- Comprehensive range of accessories

IT infrastructure

Application areas in this sector:
Racks, rack suites, server rooms

- High energy efficiency (EER) thanks to free cooling and inverter-regulated pumps
- Redundant power systems (pump, compressors etc.) ensure a high MTBF
- High levels of reliability with universal interfaces: SNMP, BACnet etc.
- High service availability 24/7

Rittal – The System.

Faster – better – everywhere.



- 1 TopTherm chiller in TS 8 enclosure
- 2 TopTherm chiller in floor-standing enclosure
- 3 Chiller for IT and process cooling
- 4 Free cooling
- 5 Air/water heat exchangers, wall-mounted
- 6 Air/water heat exchangers, roof-mounted
- 7 LCP – Liquid Cooling Package for industry
- 8 LCP – Liquid Cooling Package for IT

Convincing cooling concepts for virtually any application

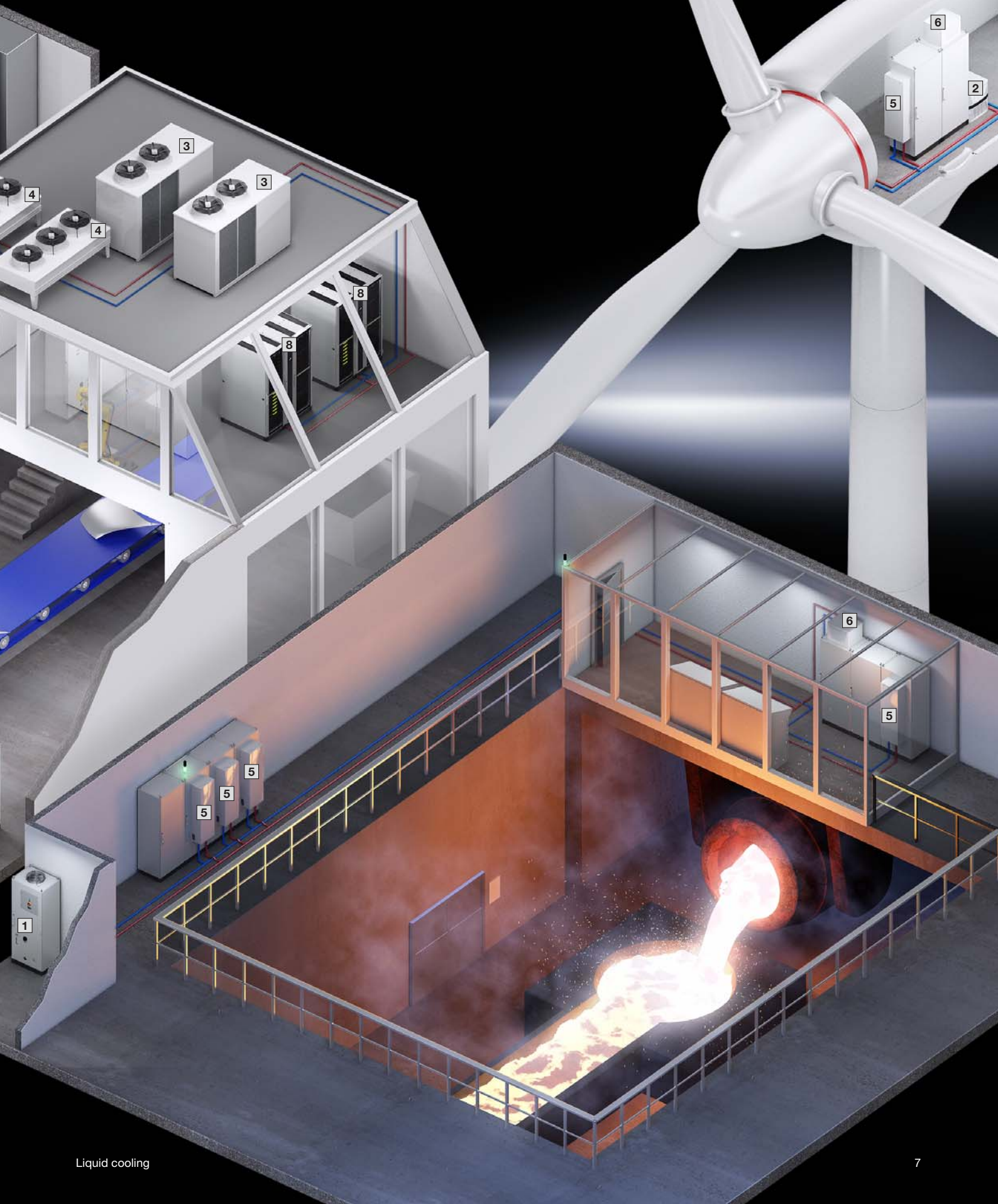

Rittal – The System.

Faster – better – everywhere.



ENCLOSURES

POWER DISTRIBUTION

CLIMATE CONTROL

TopTherm chillers – reliable and efficient

Chillers ensure centralised, efficient cooling and supply of the cooling medium (generally water), and are used with particularly high heat loads. A single pipeline system takes care of all cooling tasks on the system or machine. At the same time, the chillers ensure spatial separation between cooling generation and process cooling. They can therefore serve several pieces of equipment simultaneously, while remaining particularly efficient in terms of cooling output.

When cooling spindles with 40,000 rpm, for example, Rittal recooling systems supply volumetric flows and coolant temperatures at precisely the required level. Rittal system climate control: Your essential solution for a high degree of dimensional accuracy, consistently perfect workpieces, and stable production conditions.

Benefits at a glance:

- Cooling output from 1 to 500 kW
- One system for enclosure cooling
- Integration into bayed enclosure suites
- Individual project planning
- Commissioning and servicing
- Comprehensive pipeline calculation
- Global service network



IT INFRASTRUCTURE

SOFTWARE & SERVICES



TopTherm chillers, 1 – 40 kW



Performance diagrams Page 34 Further information can be found on the Internet

Output class kW		1 – 1.5				3 – 6			1 – 2.5	
Type of installation		Stand-alone, roof-mounted, fully internally mounted				Stand-alone, fully internally mounted			Wall-mounted	
Model No.		3318.600	3318.610	3319.600	3319.610	3320.600	3334.600	3334.660	3360.100	3360.250
Total cooling output T_w = 10°C / T_u = 32°C	kW	0.8 / 0.9	0.8 / 0.9	1.2 / 1.3	1.2 / 1.3	2.7 / 3	3.9 / 4.7	4.8 / 5.2	0.8 / 0.9	2.1 / 2.3
Total cooling output T_w = 18°C / T_u = 32°C	kW	1 / 1.1	1 / 1.1	1.5 / 1.7	1.5 / 1.7	3 / 3.4	4.5 / 5.4	6.1 / 6.6	1 / 1.1	2.5 / 2.8
Power consumption P _{el} 50/60 Hz	kW	0.69 / 1.07	0.69 / 1.07	0.86 / 0.99	0.86 / 0.99	2.03 / 2.67	2.88 / 3.24	3.98 / 5.32	1.16 / 1.21	2.2 / 2.5
Rated operating voltage	V, ~, Hz	230, 1~, 50/60				400, 3~, 50 / 460, 3~, 60			400, 3~, 50 / 460, 3~, 60	
Width	mm	600	600	600	600	602	602	605	400	400
Height	mm	400	400	400	400	676	676	1034	950	1580
Depth	mm	455	455	455	455	645	645	650	310	290
Rated current max.	A	5.1 / 5.6	5.1 / 5.6	5.7 / 5.6	5.7 / 5.6	4.05 / 4.35	5.6 / 6.15	8.2 / 8.5	4.2 / 4.0	5.5 / 5.6
Protection category (electrics)		IP 44				IP 44			IP 44	
Tank capacity	l	–	2.5	–	2.5	30			5	10
Operating temperature range		+10°C...+43°C				+10°C...+43°C			+10°C...+43°C	
Refrigerant		R134a				R134a			R134a	
Water connection		½" internal thread				½" internal thread	¾" internal thread	Quick-release coupling (mating part included in accessory bag)		
Air throughput of fans	m³/h	900				1785		2200	500	710
Pump capacity volume	l/min	3.5 / 6				20 / 44			13 / 23	
External static pressure	bar	2.5				3			1.5	
Noise pressure level	dB (A)	62				68		69	65	
Temperature hysteresis		+/- 2 K				+/- 2 K			+/- 2 K	
Temperature of liquid		+10°C...+30°C				+10°C...+30°C			+10°C...+30°C	
Weight	kg	48.0	48.0	51.0	51.0	88.0	94.0	125.0	47.0	78.0
Accessories										
Metal filters	1 pc(s).	3286.510				3286.520		2 x 3286.510	3286.410	
Levelling feet	4 pc(s).	–				7493.100			–	
Twin castors	4 pc(s).	–				6148.000			–	
Cooling medium (indoor)	10 l / 25 l					3301.960 / 3301.965				
Cooling medium (outdoor)	10 l / 25 l					3301.950 / 3301.955				

TopTherm chillers, 1 – 40 kW



Performance diagrams Page 34 Further information can be found on the Internet

Output class kW		8 – 16				20 – 40			
Type of installation		Stand-alone, system integration				Stand-alone, system integration			
Model No.		3335.790	3335.830	3335.840	3335.850	3335.860	3335.870	3335.880	3335.890
Total cooling output T_w = 10°C / T_u = 32°C	kW	6.5 / 7.5	6.5 / 7.5	10.3 / 11.3	13.8 / 15.2	16.6 / 18.7	20.8 / 23.8	27 / 30.4	32.5 / 37.5
Total cooling output T_w = 18°C / T_u = 32°C	kW	8 / 8.6	8 / 8.6	12 / 13.1	16 / 17.6	20 / 21.8	25 / 27.6	32 / 35.2	40 / 44
Power consumption P _{el} 50/60 Hz	kW	4.37 / 5.21	4.37 / 5.21	6.6 / 7.76	7.3 / 9.2	9.2 / 12	11.4 / 13.9	14.95 / 17.6	17.91 / 23.1
Rated operating voltage	V, ~, Hz	400, 3~, 50 / 460, 3~, 60				400, 3~, 50 / 460, 3~, 60			
Width	mm	805	805	805	805	1205	1205	1605	2405
Height	mm	1700	2100	2100	2140	2140	2140	2140	2140
Depth	mm	605	605	605	605	605	605	605	605
Rated current max.	A	8.23 / 7.71	8.23 / 7.71	10.03 / 11.41	12.73 / 13.3	20.12 / 17.34	22.82 / 23.84	26.25 / 26.72	38.43 / 32.66
Protection category (electrics)		IP 44				IP 44			
Tank capacity	l	75				150	75	150	
Operating temperature range		+10°C...+43°C				+10°C...+43°C			
Refrigerant		R410a				R410a			
Water connection		1" internal thread				1" internal thread	1¼" internal thread		
Air throughput of fans	m³/h	2800		6000		12200			24400
Pump capacity volume	l/min	30 / 47		30 / 55	35 / 63	43 / 76	49 / 86	55 / 70	52 / 72
External static pressure	bar	2.5				2.5		2.5 / 3.5	
Noise pressure level	dB (A)	69				70		72	
Temperature hysteresis		+/- 2 K				+/- 2 K			
Temperature of liquid		+10°C...+25°C				+10°C...+25°C			
Weight	kg	242.0	248.0	282.0	282.0	360.0	374.0	511.0	646.0
Accessories									
Metal filters	1 pc(s).	3286.550		3286.530		3286.540		2 x 3286.530	2 x 3286.540
Levelling feet	4 pc(s).	7493.100							
Twin castors	4 pc(s).	7495.000				-			
Base/plinth components		see chiller configurator on the Internet							
Cooling medium (indoor)	10 l / 25 l	3301.960 / 3301.965							
Cooling medium (outdoor)	10 l / 25 l	3301.950 / 3301.955							

Chillers for IT cooling, 15 – 500 kW



TopTherm chiller option packages Page 33 Performance diagrams Page 34 Further information can be found on the Internet

Output class kW		15 – 67					77 – 124					
Type of installation		Stand alone					Stand alone					
Model No.		3232.701	3232.711	3232.721	3232.731	3232.741	3232.751	3232.761	3232.771	3232.781	3232.791	
Total cooling output $T_w = 15^\circ\text{C} / T_u = 35^\circ\text{C}$	kW	15	24	36	48	67	77	88	99	117	124	
Total cooling output $T_w = 18^\circ\text{C} / T_u = 32^\circ\text{C}$	kW	16.7	26.4	39.6	54	75	86.2	98.5	110.9	130.5	138.5	
Integral free cooling output $T_u = 2^\circ\text{C}$	kW	19.2	19.2	27.6	27.6	76	89	109	112	135	137	
Rated operating voltage	V, ~, Hz	400, 3~, 50					400, 3~, 50					
Width	mm	810	810	810	1000	1100	1100	1100	1100	1100	1100	
Height	mm	1542	1542	1542	1780	1606	1606	1606	1606	1875	1875	
Depth	mm	1800	1800	1800	2300	3240	3240	3240	3240	3240	3240	
Power consumption ¹⁾	kW	6.9	9.7	14.6	21	21	24	26	29	36	41	
Tank capacity	l	48	48	48	100	200	200	200	200	300	300	
Operating temperature range		-20°C...+43°C					-20°C...+43°C					
Refrigerant		R407c				R410a	R410a					
Water connection		1½" Victaulic				2½" Victaulic						
Air throughput at max. cooling output	m³/h	10880	10880	14000	18000	22000	22000	27000	27000	34100	34100	
Pump capacity	l/min	60		120		240	240	240	240	470	470	
Pump pressure	bar	2.5					2.5					
Noise pressure level	dB (A)	53				42	42	43	44	50	50	
Temperature of liquid		+5°C...+20°C					+5°C...+20°C					
Number of cooling circuits		1				2	2					
Weight as delivered	kg	400	415	505	710	896	896	906	912	1119	1123	
Operating weight	kg	448	463	553	810	1096	1096	1106	1112	1419	1423	
Permissible operating pressure	bar	28				45	45					
Colour		RAL 7035				RAL 9002	RAL 9002			RAL 9002		
Accessories												
Cooling medium (indoor)	10 l / 25 l						3301.960 / 3301.965					
Cooling medium (outdoor)	10 l / 25 l						3301.950 / 3301.955					

¹⁾ With pump

Chillers for IT cooling, 15 – 500 kW



TopTherm chiller option packages Page 33 **Performance diagrams** Page 34 Further information can be found on the Internet

Output class kW		155 – 261					291 – 500					
Type of installation		Stand alone					Stand alone					
Model No.		3232.801	3232.811	3232.821	3232.891	3232.831	3232.841	3232.851	3232.861	3232.871	3232.881	
Total cooling output $T_w = 15^\circ\text{C} / T_u = 35^\circ\text{C}$	kW	155	172	196	235	262	291	326	387	430	481	
Total cooling output $T_w = 18^\circ\text{C} / T_u = 32^\circ\text{C}$	kW	172.8	191.8	219.1	272.8	292.5	325.1	364.1	432.6	480.5	537.4	
Integral free cooling output $T_u = 2^\circ\text{C}$		181	211	231	248	240	273	303	339	385	432	
Rated operating voltage	V, ~, Hz	400, 3~, 50					400, 3~, 50					
Width	mm	1100	1100	1100	1500	2200	2200	2200	2200	2200	2200	
Height	mm	1875	1875	1875	1975	2450	2450	2450	2450	2450	2450	
Depth	mm	3240	3240	4240	4350	3400	3400	3400	4250	4250	4250	
Power consumption ¹⁾	kW	47	52	60	70	80	93	106	121	141	159	
Tank capacity	l	300	300	300	700	700	700	700	700	700	700	
Operating temperature range		-20°C...+43°C					-20°C...+43°C					
Refrigerant		R410a					R410a					
Water connection		2½" Victaulic			3" Victaulic			4" Victaulic				
Air throughput at max. cooling output	m³/h	32600	32600	50000	49000	72800	71500	70200	106200	104100	102000	
Pump capacity	l/min	500	500	500	500	810	810	810	1200	1200	1200	
Pump pressure	bar	2.5					2.5					
Noise pressure level	dB (A)	50	51	53	53	56	56	56	59	58.5	58.5	
Temperature of liquid		+5°C...+20°C					+5°C...+20°C					
Number of cooling circuits		2					2					
Weight as delivered	kg	1308	1321	1489	1933	2546	2693	2843	3148	3354	3576	
Operating weight	kg	1608	1621	1789	2633	3246	3393	3543	3848	4054	4276	
Permissible operating pressure	bar	45					45					
Colour		RAL 9002					RAL 9002					
Accessories												
Cooling medium (indoor)	10 l / 25 l						3301.960 / 3301.965					
Cooling medium (outdoor)	10 l / 25 l						3301.950 / 3301.955					

¹⁾ With pump

TopTherm chiller in a floor standing enclosure, 1 – 6 kW



TopTherm chillers are used to cool liquid media, and allow a high level of temperature accuracy. The water circuit is configured as an open system with integral buffer store. Warm water flows back into this buffer store after the cooling process, and is then re-cooled to the pre-set temperature. The modular design means that the operator display for the microcontroller may be mounted on either the front or rear. The space-saving compact design turns the TopTherm chiller into the perfect cooling solution for plant and machinery engineering, and is an ideal cold water supply.

Integral monitoring systems such as pump monitoring, filter mat monitoring and connection to superordinate control units ensure that the unit will satisfy the most demanding requirements in terms of reliability and availability.

Benefits at a glance:

- Innovative control concept with microcontroller control
- Energy efficiency with eco-mode function
- Stand-by function supported with integral real-time clock
- Fixed and differential temperature setpoint control
- Nano coating as standard (on all heat exchanger membranes)
- Bifrequency design of all components
- Integral flow monitor to protect the pump from running dry
- Filter mat monitoring for a high level of operational reliability
- 2 floating fault alarm relays, freely programmable
- Communication to superordinate control unit
- No additional floor space is taken up with external enclosure mounting or internal machine mounting

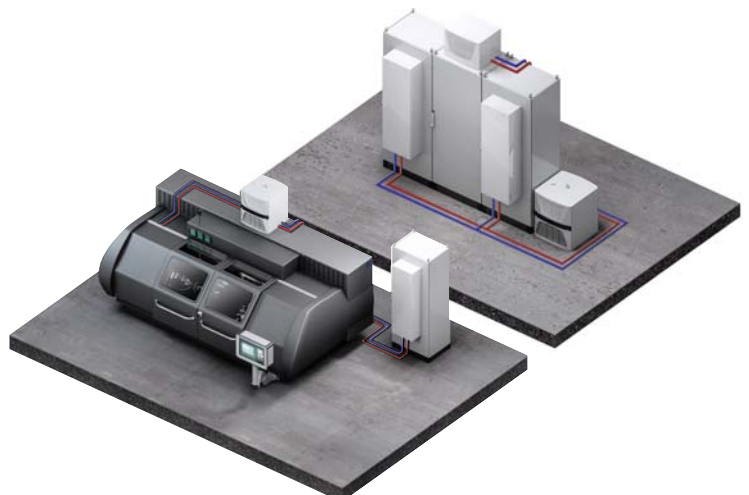

TopTherm chiller in a floor standing enclosure, 1 – 6 kW

Compact design

- Minimal footprint
- Preassembled, space-saving standard dimensions for enclosure assembly, ideally suited to all common enclosures
- Compact layout of the cooling components on a base plate which functions as a collecting tray.



High MTBF

- Nano coating as standard (on all heat exchanger membranes)
- Interactive, service-friendly filter mat monitoring for added reliability
- Precise temperature control, based on microprocessor technology
- Microcontroller box is easily replaceable

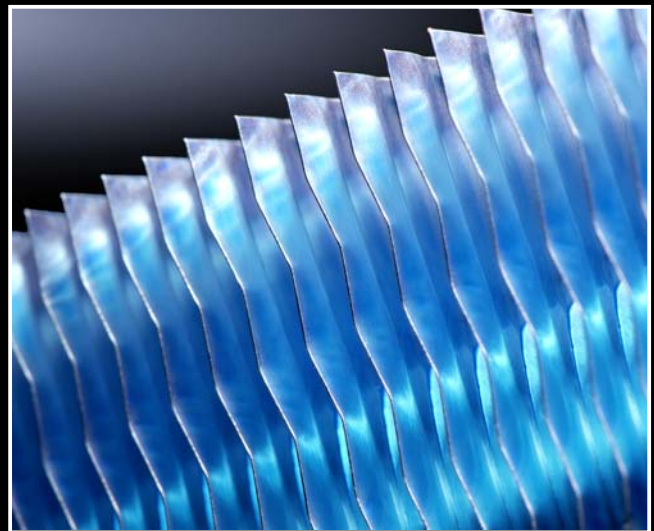

Suitable for international use

- Bifrequency version as standard
- Supports multiple voltages without rewiring
- Approvals for the world's leading markets: GS, TÜV, UL



TopTherm chillers, wall-mounted, 1 – 4 kW



TopTherm wall-mounted chillers for external enclosure mounting offer centralised cooling in a minimal space. This opens up new opportunities for integration into machine and enclosure housings in conjunction with optimum cooling output, without taking up additional floor space.

Its space-saving, compact design makes the TopTherm chiller the perfect cooling solution for plant and machine engineering, and provides an ideal cold water supply. The integral Nano coating provided as standard ensures a high MTBF.

Integral monitoring systems such as pump monitoring, filter mat monitoring and connection to superordinate control units ensure that the unit meets the most demanding requirements in terms of reliability and availability.

Benefits at a glance:

- Modular layout for external enclosure mounting, partial internal mounting and full internal mounting
- Integral flow monitor to protect the pump from running dry
- No additional floor space is taken up with internal enclosure and machine mounting
- System messages are displayed centrally
- Filter mat monitoring for a high level of operational reliability
- 2 floating fault alarm relays, freely programmable
- Communication with superordinate control unit
- Energy efficiency with eco-mode function
- Stand-by function supported with integral real-time clock
- Nano coating as standard (on all heat exchanger membranes)

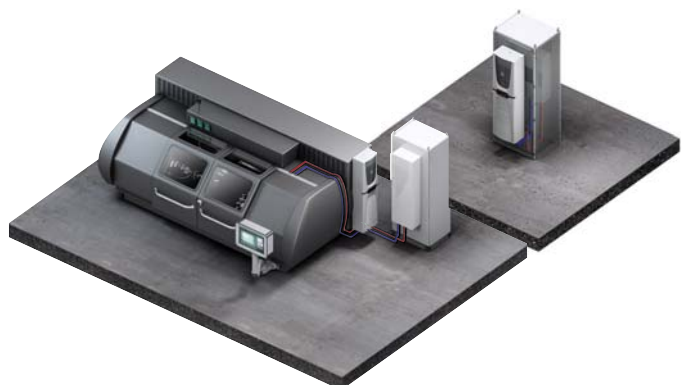

TopTherm chillers, wall-mounted, 1 – 4 kW

Flexible mounting

- Three mounting variants ensure flexibility:
Full internal mounting, partial internal mounting or external mounting
- Optimum use of the available space
- No additional floor space is taken up, thanks to the innovative assembly form
- May be integrated into machine systems



High MTBF

- Special internal or external mounting kits are not required: Quick-release fastener coupling, including mating component, ensures fast commissioning
- Water connections and electric control unit accessible from the outside
- Interactive, service-friendly filter mat monitoring for added reliability
- Precise temperature control, based on microprocessor technology



Integrated as standard

- Fill level display
- Filter mat monitoring
- Pump to convey the medium



TopTherm chiller in a TS 8 enclosure, 8 – 40 kW



Chillers have proven ideal for providing powerful, targeted climate control in industrial applications. The TopTherm chiller in the TS 8 system enclosure from Rittal is a particular highlight, since the modular chiller covers seven cooling outputs ranging from 8 to 40 kW with just four sizes. This translates into savings across the board, since rather than customised production, the TopTherm chiller is a standardised climate control solution with a full performance range available off the shelf. The dual frequency design of the control module makes it suitable for international use. The temperature may be set as a fixed or differential value. The micro-controller with intelligent logic reduces the number of component on/off switching cycles and enhances energy efficiency. Cleverly designed: The TopTherm chiller based on the TS 8 enclosure integrates the electrical controller as well as the water and cooling module, and spare parts management is reduced to a bare minimum.

Benefits at a glance:

Premanufactured standard modules

- Integration into the TS 8 system
- Service availability up to 24 hours worldwide
- Standardised modules for a reduced range of spare parts

Efficient components

- High reliability thanks to integral icing protection on the heat exchanger
- Refrigerant R410a

Greater flexibility

- Output range 8 – 40 kW
- Small footprint thanks to vertical design
- One version for two frequencies = international compatibility
- Broad application spectrum, thanks to predefined option packages



TopTherm chiller in a TS enclosure, 8 – 40 kW

Cost pressure and global component availability are necessitating the widespread standardisation of recooling systems. Rittal has recognised this trend and developed the TopTherm chiller, with its modular design. As it is based on a TS 8 enclosure, it may be fully integrated into the Rittal system. The modular design is based around standardised individual modules, to ensure a high level of flexibility.

1 Control module

- One design, two frequencies: 400 V/50 Hz, 460 V/60 Hz
- Fixed or differential temperature setpoint control, switchable
- Optimised microcontroller control
- Master switch in black (optional)
- Prefitted Harting connector (optional)
- Electrical components in UL variant (optional)

2 Cooling module

- Refrigerant R410a
- Modules with different outputs are readily exchanged
- Optimum thermodynamics
- Energy efficiency is increased by using the water-cooled condenser (optional)
- Winter control up to -20°C (optional)

3 Water module

- PP tank – Pre-formed from a single piece
- Variable pump selection (optional)
- Water level monitoring (optional)
- Water circuit free from non-ferrous metals (optional)



TopTherm chillers, 8 – 40 kW

Optimum integration into existing TS 8 enclosure combinations. Modular assembly with standardised enclosure dimensions. Dimensions are given without the condenser fan.

Enclosure	Dimensions W x H x D mm	Output kW
1	800 x 2000 x 600	8 – 12 – 16
2	1200 x 2000 x 600	20 – 25
3	1600 x 2000 x 600 ¹⁾	32
4	2400 x 2000 x 600 ²⁾	40

¹⁾ = 2 x enclosure 1
²⁾ = 2 x enclosure 2

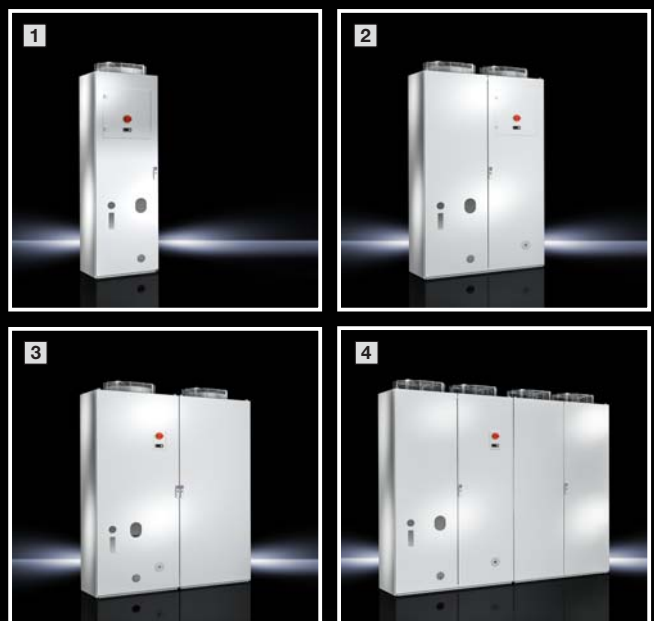

Chillers for IT cooling, 15 – 500 kW



The Rittal IT chiller in conjunction with free cooling supplies exceptionally energy- and cost-efficient IT cooling media. The system is specially designed for supplying critical IT applications cooled via LCP, air/water heat exchangers or CRAC systems. The flexible design ensures optimised process cooling applications.

In this atmospherically sealed system, options such as redundant, speed-regulated pumps, compressors, emergency cooling and buffer stores mean optimum operational reliability and fail-safeness.

Alongside optional heat recovery from the system, connection to Rittal free cooling recooling systems ensures exceptionally energy-efficient operation. Free cooling uses cold ambient air for cooling, reduces operating costs by up to 80%, extends the service life of components, and increases operational reliability. If the free cooling performance is insufficient, the IT chiller will cut in.

Benefits at a glance:

- Redundant pumps, speed-controlled
- Redundant compressors
- 2 cooling circuits from 50 kW
- Intelligent control concept
- Interfaces: SNMP, BACnet, MODBUS
- Integral or separate free coolers (optional)
- Integral automatic bypass valve
- Integral flow monitor
- Operating costs are minimised, thanks to high water inlet temperatures for LCP and CRAC operation
- High EER (energy efficiency ratio)
- Integration into RiZone software
- Suitable for universal use, including process cooling, for example
- Suitable for outdoor siting up to $T_u = -20^{\circ}\text{C}$

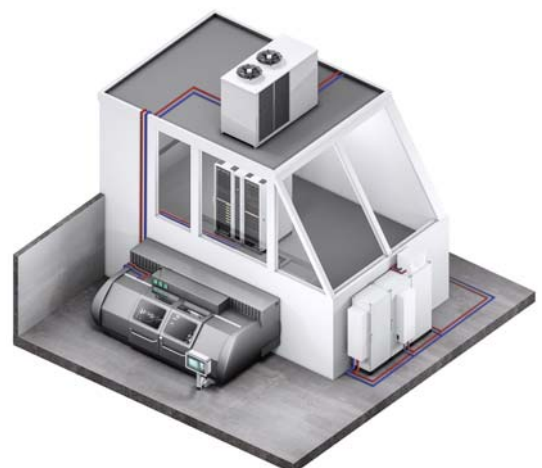

Chillers for IT cooling, 15 – 500 kW

High energy efficiency – Low operating costs

- Pump with integral frequency converter (optional)
- Free cooling for the entire output range (optional)
- Energy-efficient operation with redundant scroll compressor
- Intelligent control concept
- Optimum heat exchanger design for maximum energy efficiency



Reliability and redundancy

- 2 redundant pumps
- Up to 8 chillers may be combined
- In the event of a power failure, the pump and controller are supplied via an external UPS
- Automatic changeover from mains to UPS
- Integral flow monitor
- Integral automatic bypass valve

- | | |
|-----------------------------------|--------------------------|
| 1 Compressor with oil sump heater | 13 Controller |
| 2 Duo pressure monitor LP/HP | 14 Drain/fill |
| 3 Condenser with fan | 15 Pressure relief valve |
| 4 Non-return valve | 16 Bypass valve |
| 5 Pressure sensor | 17 Manometer |
| 6 Expansion valve | 18 Pump |
| 7 Inspection glass | 19 Return IN |
| 8 Magnetic valve | 20 Inlet OUT |
| 9 Dryer | 21 Tank |
| 10 Evaporator coil | 22 Refrigerant collector |
| 11 Safety assembly | |
| 12 Flow monitor | |

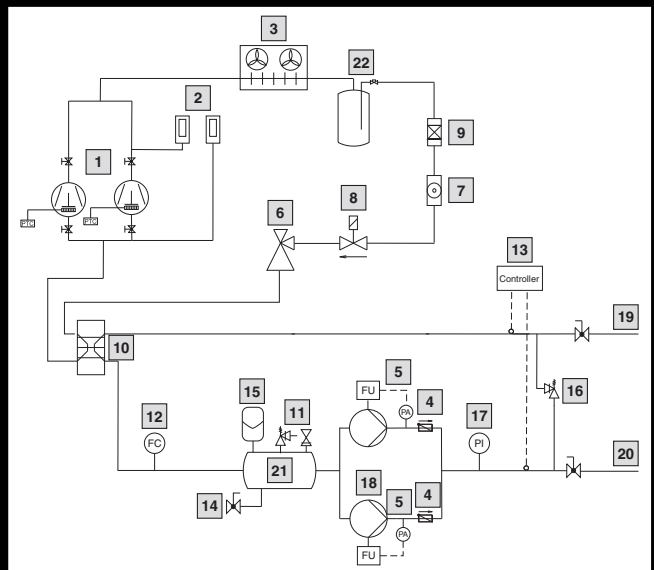

Variable pumps with integral frequency converter

- Available for the entire output range
- Linear output control with integral frequency converter
- With two sensors to monitor pressure
- Constant pressure always available for the equipment
- Where there is variable consumption by the equipment (e.g. LCPs) or in the cooling circuit (e.g. free cooling), the pump is self-regulating and generates a constant pressure
- In special applications, a constant water flow rate is also supported

Benefits for the customer:

- Demand-based pump speed ensures a high level of energy efficiency
- Only consumes what is actually needed



Rittal – The System.

Faster – better – everywhere.



ENCLOSURES

POWER DISTRIBUTION

CLIMATE CONTROL

FRIEDHELM LOH GROUP

Air/water heat exchangers – Efficient and ambient air-neutral

The enclosure interior air may also be cooled to below the level of the external temperature, if required, by using cooling water from a central recooling system. The ingress of external dust into the cooled enclosure is prevented. The waste heat from the enclosure does not raise the temperature of the ambient air, provided the heat exchanger and cold water supply system are spatially separated from one another.

Air/water heat exchangers can also be used at extreme ambient temperatures ranging from +1°C to +70°C. Even extreme levels of contamination in the ambient air, e.g. with dust and oil, do not affect functionality. High heat loads are dissipated in the most confined space. A high operating ratio is achieved, thanks to the large surface area of the heat exchanger unit and the powerful EC fan technology.

Benefits at a glance:

- Also available with all water-carrying parts made from stainless steel
- High protection category IP 55 to IEC 60 529
- Virtually maintenance-free
- Control of the air and water circuit is electronically monitored

Please note:

Air/water heat exchangers should always be used in conjunction with recooling systems or an existing cooling water circuit.



Air/water heat exchangers, 0.3 – 5 kW



Accessories Page 32 Performance diagrams Page 36 Further information can be found on the Internet

Output class kW		0.3 – 0.5					0.6 – 1			
Type of installation		Wall-mounted					Wall-mounted			
Model No.		3212.024	3212.115	3212.230	3363.100	3363.500	3214.100	3364.504	3364.100	3364.500
Water-carrying parts	Stainless steel (1.4571)	–					–	■	–	–
	Copper/brass (Cu/CuZn)	■					■	–	■	■
Temperature control	Basic controller (factory setting +35°C)	–	–	–	■	–	–	–	■	–
	e-Comfort controller (factory setting +35°C)	–	–	–	–	■	–	■	–	■
	Thermostat-controlled magnetic valve	–	–	–	–	–	■	–	–	–
Total cooling output L35 W10, 200 l/h kW		0.3	0.3	0.3	–	–	0.6	–	–	–
Total cooling output L35 W10, 400 l/h kW		–	–	–	0.5	0.5	0.7	0.95	1	1
Rated operating voltage V, ~, Hz		24 (DC)	115, 1~, 50/60	230, 1~, 50/60			230, 1~, 50/60			
Width mm		150	150	150	280	280	200	280	280	280
Height mm		300	300	300	550	550	500	550	550	550
Depth mm		85	85	85	120	120	100	120	120	120
Power consumption P _{el} 50/60 Hz W		26	26 / 30	23 / 27	37 / 38	37 / 38	36 / 37	37 / 38	37 / 38	37 / 38
Operating temperature range		+1°C...+70°C					+1°C...+70°C			
Setting range		–	–	–	+20°C...+55°C		+20°C...+55°C			
Water inlet temperature		+1°C...+30°C					+1°C...+30°C			
Water connection	½" connector sleeve	–	–	–	■	■	■	■	■	■
	G ¾" external thread	–	–	–	■	■	–	■	■	■
	¾" connector sleeve	■	■	■	–	–	–	–	–	–
Permissible operating pressure (p max.) bar		1 – 10					1 – 10			

Air/water heat exchangers, 0.3 – 5 kW



Accessories Page 32 Performance diagrams Page 36 Further information can be found on the Internet

Output class kW		1.25 – 3					3 – 5			
Type of installation		Wall-mounted					Wall-mounted			
Model No.		3215.100	3373.100	3373.500	3374.504	3374.100	3374.500	3375.504	3375.100	3375.500
Water-carrying parts	Stainless steel (1.4571)	–	–	–	■	–	–	■	–	–
	Copper/brass (Cu/CuZn)	■	■	■	–	■	■	–	■	■
Temperature control	Basic controller (factory setting +35°C)	–	■	–	–	■	–	–	■	–
	e-Comfort controller (factory setting +35°C)	–	–	■	■	–	■	■	–	■
	Thermostat-controlled magnetic valve	■	–	–	–	–	–	–	–	–
Total cooling output L35 W10, 200 l/h kW		1.25	–	–	–	–	–	–	–	–
Total cooling output L35 W10, 400 l/h kW		1.3	2	2	2.8	3	3	4.5	5	5
Rated operating voltage V, ~, Hz		230, 1~, 50/60					230, 1~, 50/60			
Width mm		200	400	400	400	400	400	450	450	450
Height mm		950	950	950	950	950	950	1400	1400	1400
Depth mm		100	145	145	145	145	145	220	220	220
Power consumption P _{el} 50/60 Hz W		83 / 85	110 / 140	110 / 140	169 / 232	169 / 232	169 / 232	170 / 170	170 / 170	170 / 170
Operating temperature range		+1°C...+70°C					+1°C...+70°C			
Setting range		+20°C...+55°C					+20°C...+55°C			
Water inlet temperature		+1°C...+30°C					+1°C...+30°C			
Water connection	½" connector sleeve	■	■	■	■	■	■	■	■	■
	G ¾" external thread	–	■	■	■	■	■	■	■	■
	¾" connector sleeve	–	–	–	–	–	–	–	–	–
Permissible operating pressure (p max.) bar		1 – 10					1 – 10			

Air/water heat exchangers, 1.8 – 7 kW



Accessories Page 32 Performance diagrams Page 36 Further information can be found on the Internet

Output class kW		7	1.8 – 4					
Type of installation		Wall-mounted	Roof-mounted					
Model No.		3216.480	3209.504	3209.100	3209.500	3210.504	3210.100	3210.500
Water-carrying parts	Stainless steel (1.4571)	–	■	–	–	■	–	–
	Copper/brass (Cu/CuZn)	■	–	■	■	–	■	■
Temperature control	Basic controller (factory setting +35°C)	–	–	■	–	–	■	–
	e-Comfort controller (factory setting +35°C)	–	■	–	■	■	–	■
	Thermostat-controlled magnetic valve	■	–	–	–	–	–	–
Total cooling output L35 W10, 400 l/h kW		–	1.8	2.5	2.5	3	4	4
Total cooling output L35 W10, 500 l/h kW		7	–	–	–	–	–	–
Total cooling output L35 W20, 500 l/h kW		4.5	–	–	–	–	–	–
Total cooling output L35 W10, 2000 l/h kW		–	–	–	–	–	–	–
Rated operating voltage V, ~, Hz		400, 3~, 50 460, 3~, 60	230, 1~, 50/60					
Width mm		450	597	597	597	597	597	597
Height mm		1800	417	417	417	417	417	417
Depth mm		300	475	475	475	475	475	475
Power consumption P _{el} 50/60 Hz W		98 / 115	95 / 110	95 / 110	95 / 110	98 / 115	98 / 115	98 / 115
Operating temperature range		+1°C...+70°C	+1°C...+70°C					
Setting range		+20°C...+55°C	+20°C...+55°C					
Water inlet temperature		+1°C...+30°C	+1°C...+30°C					
Water connection	½" connector sleeve	■	■	■	■	■	■	■
	G ¾" external thread	■	■	■	■	■	■	■
	¾" connector sleeve	–	–	–	–	–	–	–
Permissible operating pressure (p max.) bar		1 – 10	1 – 10					

LCP – Liquid Cooling Package, 10 kW

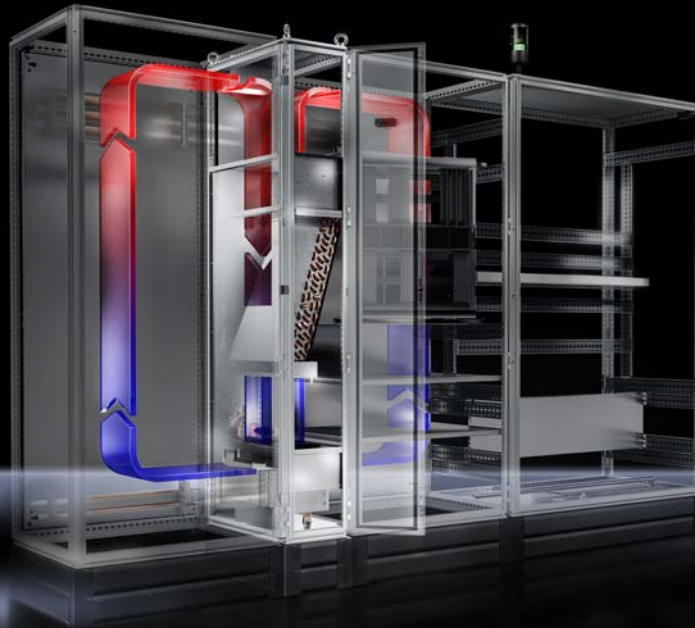

Accessories Page 32 Performance diagrams Page 37 Further information can be found on the Internet

Output class kW		10	
Type of installation		LCP Rack Industry	
Model No.		3378.200	3378.280
Water-carrying parts	Stainless steel (1.4571)	–	–
	Copper/brass (Cu/CuZn)	■	■
Temperature control	Basic controller (factory setting +35°C)	–	–
	e-Comfort controller (factory setting +35°C)	■	■
	Thermostat-controlled magnetic valve	–	–
Total cooling output L35 W10, 400 l/h kW		–	–
Total cooling output L35 W10, 500 l/h kW		–	–
Total cooling output L35 W20, 500 l/h kW		–	–
Total cooling output L35 W10, 2000 l/h kW		9.5	9.5
Rated operating voltage V, ~, Hz		230, 1~, 50/60	230, 1~, 50/60
Width mm		300	300
Height mm		2000	2000
Depth mm		600	800
Power consumption P _{el} 50/60 Hz W		350 / 406	350 / 406
Operating temperature range		+5°C...+70°C	+5°C...+70°C
Setting range		+20°C...+55°C	+20°C...+55°C
Water inlet temperature		> +7°C...+30°C	
Water connection	¾" internal thread	■	■
	¾" connector sleeve	–	–
	¾" connector sleeve	–	–
Permissible operating pressure (p max.) bar		1 – 6	

Air/water heat exchangers



Compact and lightweight: Air/water heat exchangers have a low weight and a comparatively low volume in relation to the heat loss to be dissipated. As a result, they are easily mounted on vertical enclosure surfaces or on the roof.

Benefits at a glance:

- Extensive choice of water connection options
 - ½" connector sleeve
 - Fixed pipework with G¾" external thread
 - Fixed pipework with G¾" internal thread (accessory)
- Flexible installation options
- Integral leak monitoring ensures comprehensive functional reliability
- 2 control concepts with Basic and Comfort controller
- Energy efficient eco-mode control
- International approvals (UR, cUR, CSA)

Comprehensive functional reliability

Enhanced functional reliability and a long service life

For undefined cooling media, or even well water, air/water heat exchangers are available with all water carrying parts made from stainless steel 1.4571 (V4A). Corrosion is virtually excluded.

- From 0.5 to 7 kW useful cooling capacity to suit every requirement

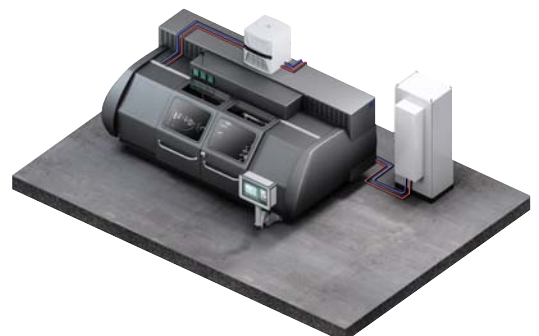

Air/water heat exchangers

Meticulously planned variants

- **Wall mounting**
For mounting on the wall or any sufficiently large vertical surface.
- **Roof mounting**
Especially for bayed enclosures, where wall-mounted devices would obstruct the door.

More effective cooling with targeted air routing

One key feature of the TopTherm roof-mounted units: Cool air from the heat exchanger is directed precisely to the required assembly via an air duct system.

The result: Highly efficient, cost-effective cooling.

Another cost benefit: The air duct system is also compatible with roof-mounted cooling units!



Choice of variants

The air/water heat exchangers are available in two different variants.

Basic controller

- Visualisation of the current enclosure internal temperature and all system messages on the display
- Setpoint adjustment (setting range +20°C...+55°C)
- Switching hysteresis: 5 K
- Floating fault alarm relay (overtemperature and undertemperature warning)
- Condensate warning/leak monitoring (only with roof-mounted cooling units)

e-Comfort controller

- Visualisation of the current enclosure internal temperature and all system messages on the display
- Setpoint adjustment (setting range +20°C...+55°C)
- Switching hysteresis: 2 K...10 K; preset to 5 K
- Two floating fault alarm relays (normally open contacts) to which system messages may be assigned
- Condensate warning/leak monitoring
- Master/slave function for up to 10 units
- All system statuses are saved in the log file
- All system messages can be read via RiDiag diagnosis software
- Energy efficient eco-mode control
- Integral non-return valve
- Temperature control via internal fan supported (magnetic valve permanently open)
- Door limit switch function



Sample application

Parallel connection of two air/water heat exchangers

Parallel connection of air/water heat exchangers with cold water supply via a recooling system. Overflow valves and bypass control should be integrated into the recooling system and the customer's own pipeline system respectively.

- | | |
|--|--|
| <ul style="list-style-type: none"> 1 Recooling system 2 Air/water heat exchanger 3 Overflow valve (bypass function with the magnetic valve of the air/water heat exchanger closed), Model No.: 3301.900/910/920 | <ul style="list-style-type: none"> 4 Flow regulator valve (for volumetric flow control of air/water heat exchangers), see accessories page 32 5 Non-return valve (optional) 6 Magnetic valve (optional) |
|--|--|

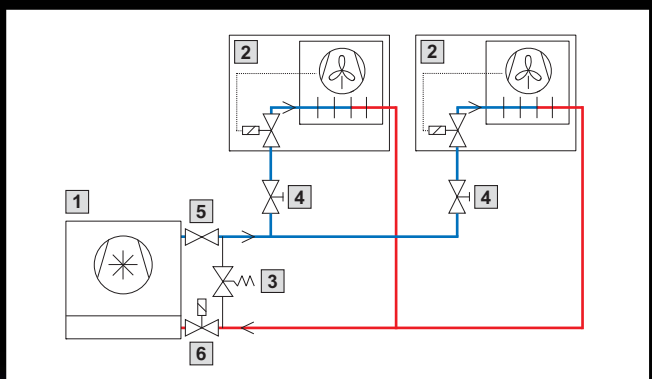

LCP – Liquid Cooling Package for industry

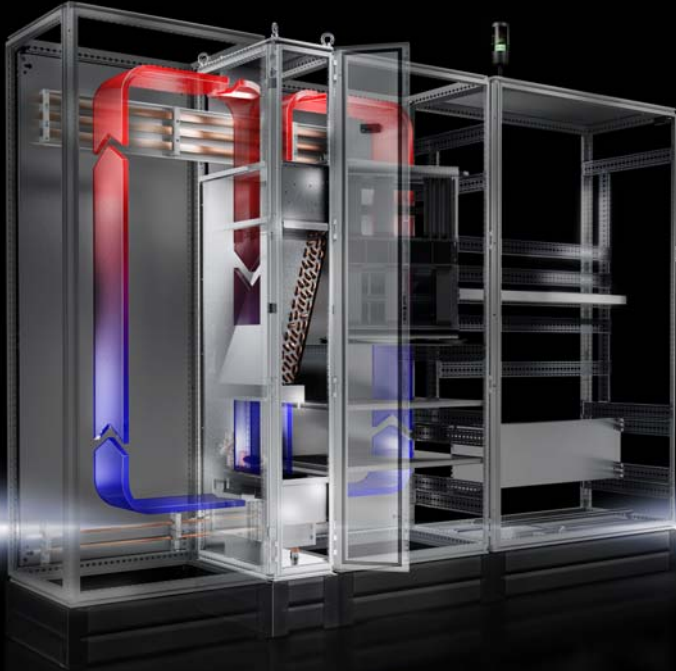

The air/water heat exchangers in the TS 8 baying system fit 600 or 800 mm deep, 2000 mm high TS 8 enclosures. The separation between cooling and enclosure prevents water from penetrating the enclosure, and makes it very easy to assemble and service. The LCP Industry is easy to handle and may be transported in lifts and through doors. The low weight means a minimal floor load. Among industrial applications, there is a growing demand for air/water heat exchangers that can achieve a cooling output spectrum of up to 10 kW. Based on very positive experiences with IT cooling, Rittal has developed the high-performance Industry LCP (Liquid Cooling Package) especially for use in industrial environments.

Apart from their high achievable cooling output, the other major benefit of these heat exchangers is that they are readily integrated into the Rittal TS 8 enclosure system.

The heat exchanger supports flexible installation in the enclosure system. Depending on the required cooling output, air can be routed on one side to the left, to the right or, if placed centrally, on both sides.

Benefits at a glance:

- Virtually maintenance-free operation
- Minimal noise emissions
- Lower operating costs than compressor cooling units
- Compact design
- Water connection options on the top and bottom of the unit.

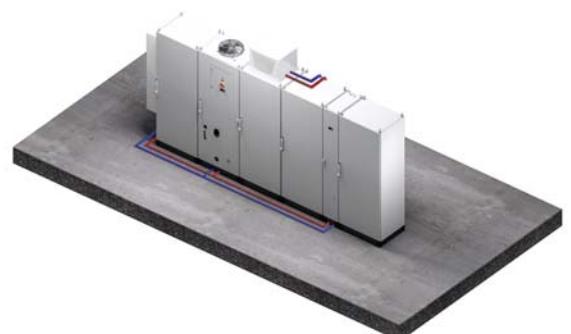

LCP – Liquid Cooling Package for industry

Convincing climate control concept

- **Fits perfectly into the system**
Bayable to all 600 or 800 mm deep, 2000 mm high TS 8 enclosures
- **Maximum performance in a minimal space**
Air outlet with either 5 kW on each side or 10 kW on one side only
- **Flexible water connection**
Flexible water connection options are available on the top or bottom of the unit
- **Flexible applications**
Busbars and cables are readily routed through the unit at the top and bottom. In this way, even bayed enclosure suites may be integrated and supplied with a high cooling output.
- **Energy efficiency**
EC fans and Comfort controllers for even greater efficiency



Variable baying

- 1 At the beginning or end of an enclosure suite, air routing on one side
- 2 Within an enclosure suite, air routing on both sides
- 3 Within an enclosure suite, air routing on one side, optional sealing of the air inlet and outlet openings

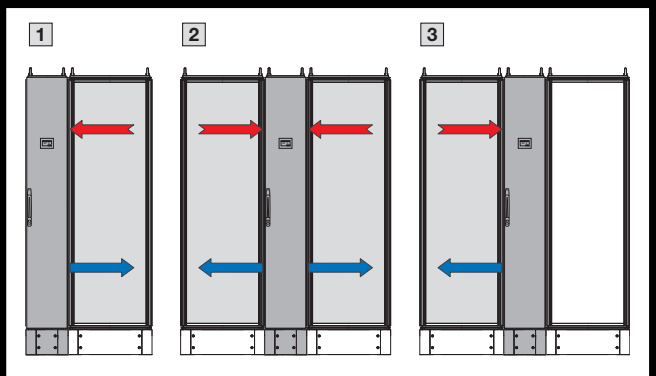

Air/water heat exchangers – Accessories

Model No. Air/water heat exchanger		3209.1XX	3209.5XX	3210.1XX	3210.5XX	3363.1XX	3363.5XX	3364.1XX	3364.5XX	3373.1XX	3373.5XX	3374.1XX	3374.5XX	3375.1XX	3375.5XX	3212.024	3212.115	3212.290	3214.100	3215.100	3216.480	3378.XXX	
Fitting G$\frac{3}{8}$"																							
	<p>Fitting G$\frac{3}{8}$"</p> <p>G$\frac{3}{8}$" internal thread</p> <p>The internal threaded adaptor can be used to create fixed piping on the air/water heat exchanger for both the inlet and return.</p>	3201.900	■	■	■	■	■	■	■	■	■	■	■	■	■	-	-	-	-	-	-	-	
Air duct system¹⁾																							
	<p>Air duct system¹⁾</p> <p>Cold air may be routed directly to specific areas of the enclosure using the air duct system.</p>	3286.870	■	■	■	■	-	-	-	-	-	-	-	-	-	-	-	-	-	-	-	-	
	<p>Flat (for TS 8 enclosures with widths of 800 mm or more and depths of 600 mm or more)</p>	3286.850	■	■	■	■	-	-	-	-	-	-	-	-	-	-	-	-	-	-	-	-	
Door-operated switch																							
	<p>Door-operated switch</p> <p>Without connection cable</p> <p>For deactivation of air/water heat exchangers whilst the door is open or for monitoring the door.</p>	4127.010	-	■	-	■	-	■	-	■	-	■	-	■	-	-	-	-	-	-	■		
Flow regulator valve																							
	<p>Flow regulator valve</p> <p>For regulating the volumetric flow, particularly if more than one heat exchanger is used in one cooling water circuit (setting range 3 – 12 l/min)</p>	G $\frac{3}{4}$ " x Rp $\frac{1}{2}$ "	3301.930	■	■	■	■	■	■	■	■	■	■	■	■	■	■	■	■	■	■	-	
		G $\frac{3}{4}$ " x G $\frac{3}{4}$ "	3301.940	■	■	■	■	■	■	■	■	■	■	■	■	■	■	■	■	■	■	■	-
Connection set																							
	<p>Connection set</p> <p>For professional laying of water connections and regulation of volumetric flow. The pressure hoses may be cut to length individually (max. length 3.60 m), depending on the application.</p>	3201.990	■	■	■	■	■	■	■	■	■	■	■	■	■	-	-	-	-	-	■	-	
Toroidal transformer																							
	<p>Toroidal transformer</p> <p>115 V (primary), 2~, 50/60 Hz 230 V (secondary), 1~, 50/60 Hz</p>	3201.970	-	-	-	-	■	■	■	■	-	-	-	-	-	-	-	-	■	■	-	-	
	<p>400 V (primary), 2~, 50/60 Hz 230 V (secondary), 1~, 50/60 Hz</p>	3201.960	-	-	-	-	■	■	■	■	-	-	-	-	-	-	-	■	■	■	-	-	
Master-slave cable for SK BUS system																							
	<p>Master-slave cable for SK BUS system</p> <p>The SK BUS system allows several air/water heat exchangers with e-Comfort controller to communicate with one another.</p>	3124.100	-	■	-	■	-	■	-	■	-	■	-	■	-	-	-	-	-	-	-	■	
Interface board																							
	<p>Interface board</p> <p>Extension for equipment with e-Comfort controller. In this way it is possible, e.g. to monitor a master/slave combination of up to 10 air/water heat exchangers.</p>	3124.200	-	■	-	■	-	■	-	■	-	■	-	■	-	-	-	-	-	-	-	■	
Cooling medium for chillers and air/water heat exchangers																							
	<p>Cooling medium for chillers and air/water heat exchangers</p> <p>As well as protecting against frost, this cooling medium also serves to inhibit bacterial growth and provide optimum corrosion protection.</p>	Indoor	10 l	3301.960	■	■	■	■	■	■	■	■	■	■	■	■	■	■	■	■	■	■	
			25 l	3301.965	■	■	■	■	■	■	■	■	■	■	■	■	■	■	■	■	■	■	■
		Outdoor	10 l	3301.950	■	■	■	■	■	■	■	■	■	■	■	■	■	■	■	■	■	■	■
			25 l	3301.955	■	■	■	■	■	■	■	■	■	■	■	■	■	■	■	■	■	■	■

¹⁾ TS support strips additionally required, see Catalogue 34, page 609

Chiller option packages

Options	1	2	3	4	5	6	7	8	9	10	11	12	13	14	15	16	17	18	19	20	21	22	23	24	25	26	27	28	29	30	31	32	33			
Hydraulic water bypass (overflow valve)																																				
Water level switch																																				
Industry plug connector																																				
More powerful pump(s)																																				
Metal filter mat																																				
Special spray finish																																				
Ambient temperature control																																				
High-precision temperature hysteresis																																				
Upstream pipework, free from non-ferrous metals																																				
Feet/plinth																																				
Castors for flexible positioning																																				
Flow monitor																																				
Outdoor siting																																				
Low ambient temperature up to -20°C																																				
Water-cooled condenser																																				
Stainless steel enclosure																																				
1 speed controlled pump																																				
2 speed controlled pumps																																				
1 standard pump																																				
2 standard pumps																																				
Buffer store + hydraulic kit																																				
Free cooling kit: Free cooling system integrated into chiller																																				
Free cooling kit: External free cooling system																																				
Steel buffer store, insulated, for separate siting																																				
SNMP interface board																																				
Serial Modbus output card																																				
Winter kit up to -40°C																																				
Energy efficiency monitoring kit																																				
Emergency cooling kit via mains water																																				
Condenser with protective grille																																				
Glycol protectors for water-polluting substances																																				
Vibration dampers																																				
Transport kit																																				
TopTherm chillers, cooling output 1 – 6 kW																																				
3318.600																																				
3318.610																																				
3319.600																																				
3319.610																																				
3320.600																																				
3334.600																																				
3334.660																																				
TopTherm chillers, wall-mounted, cooling output 1 – 4 kW																																				
3360.100																																				
3360.250																																				
3360.470																																				
TopTherm chillers, cooling output 8 – 40 kW																																				
3335.790																																				
3335.830																																				
3335.840																																				
3335.850																																				
3335.860																																				
3335.870																																				
3335.880																																				
3335.890																																				
Chillers for IT cooling, cooling output 15 – 500 kW																																				
3232.701																																				
3232.711																																				
3232.721																																				
3232.731																																				
3232.741																																				
3232.751																																				
3232.761																																				
3232.771																																				
3232.781																																				
3232.791																																				
3232.801																																				
3232.811																																				
3232.821																																				
3232.891																																				
3232.831																																				
3232.841																																				
3232.833																																				
3232.834																																				
3232.871																																				
3232.881																																				

■ Standard □ Option ■ Accessories

Performance diagrams

TopTherm chillers/chillers for IT cooling

TopTherm chillers

Output class 1 – 6 kW, 50 Hz at $T_u = 32^\circ\text{C}$

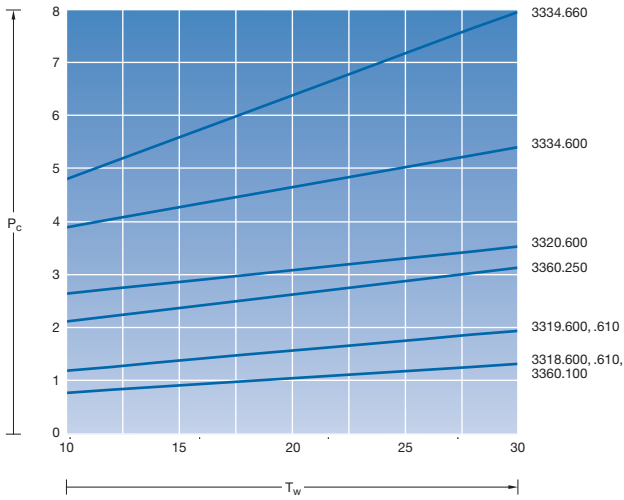

Output class 8 – 40 kW, 50 Hz at $T_u = 32^\circ\text{C}$

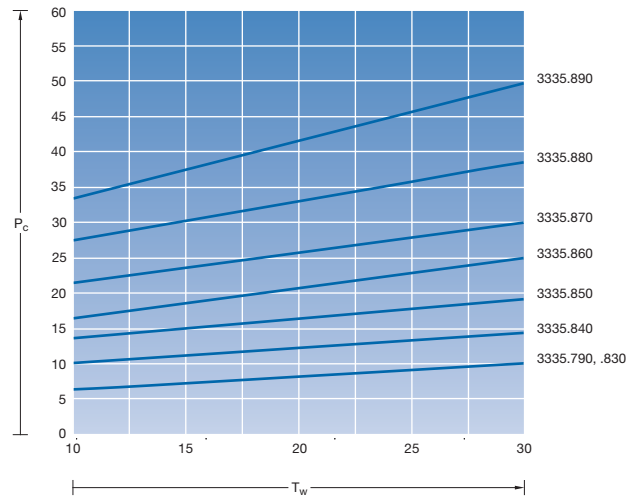

Chillers for IT cooling

Output class 15 – 124 kW, 50 Hz, $T_u = 35^\circ\text{C}$

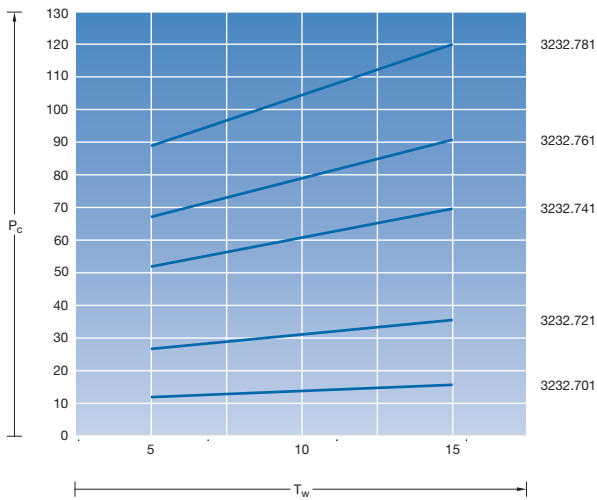

Output class 155 – 500 kW, 50 Hz, $T_u = 35^\circ\text{C}$

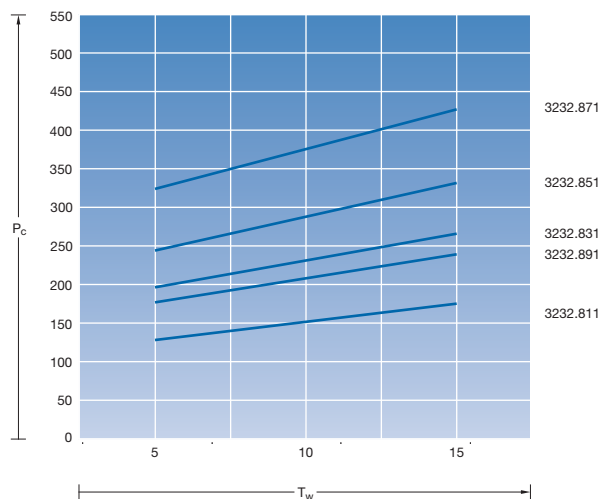
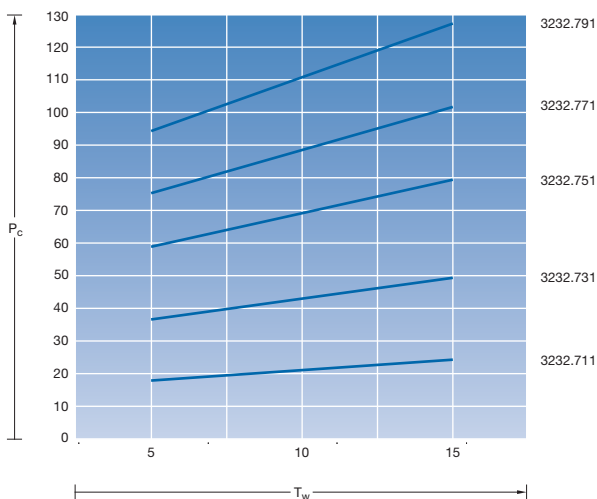
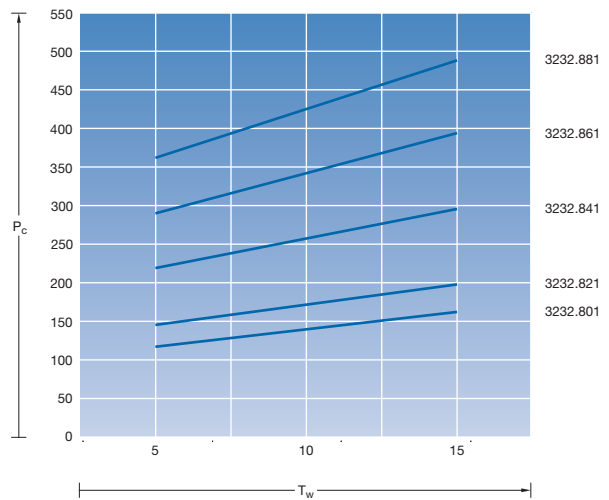

T_w = Water inlet temperature ($^\circ\text{C}$)
 P_c = Total cooling output (kW)

Characteristic curves of pump TopTherm chillers

TopTherm chillers

Output class 1 – 6 kW, 50 Hz at $T_u = 32^\circ\text{C}$

SK 3318.600/.610,
SK 3319.600/.610

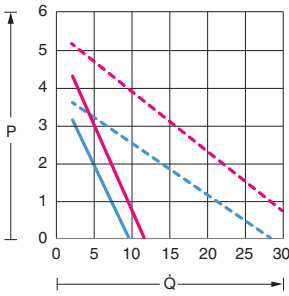

SK 3320.600/
SK 3334.600/.660

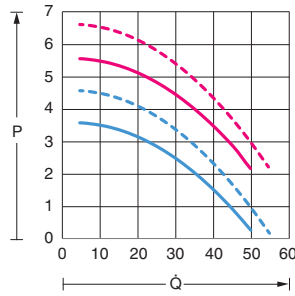

SK 3360.100/.250

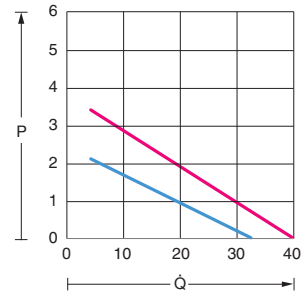

Output class 8 – 40 kW, 50 Hz at $T_u = 32^\circ\text{C}$

SK 3335.790/.830

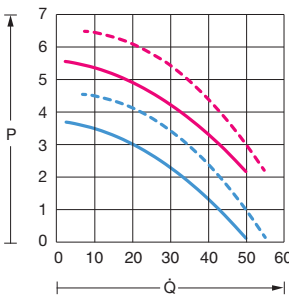

SK 3335.840

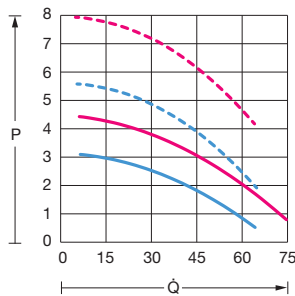

SK 3335.850

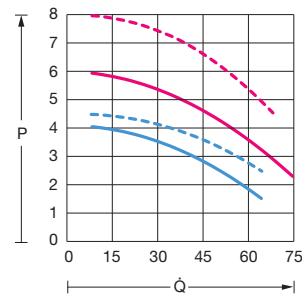

SK 3335.860

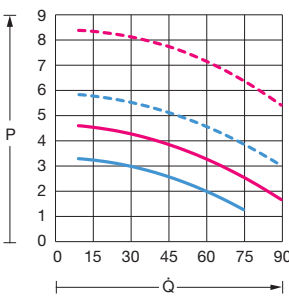

SK 3335.870

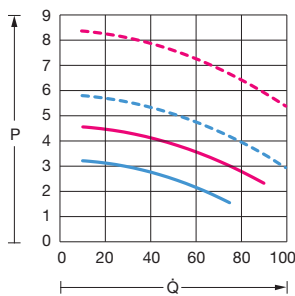

SK 3335.880

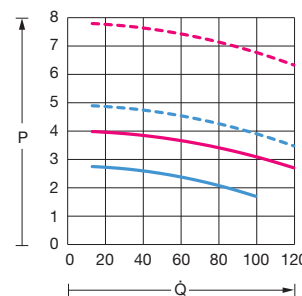

SK 3335.890

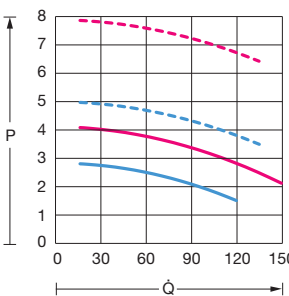

P = External static pressure [bar]
Q-dot = Delivery flow Q [l/min]

Standard pump
— = 50 Hz
— = 60 Hz

Reinforced pump (optional)
- - = 50 Hz
- - = 60 Hz

Performance diagrams

Air/water heat exchangers

**Output class 0.5 – 5 kW,
50 Hz, wall-mounted/roof-mounted**
Water-carrying parts: Copper/brass (Cu/CuZn)
Volumetric flow: 400 l/h

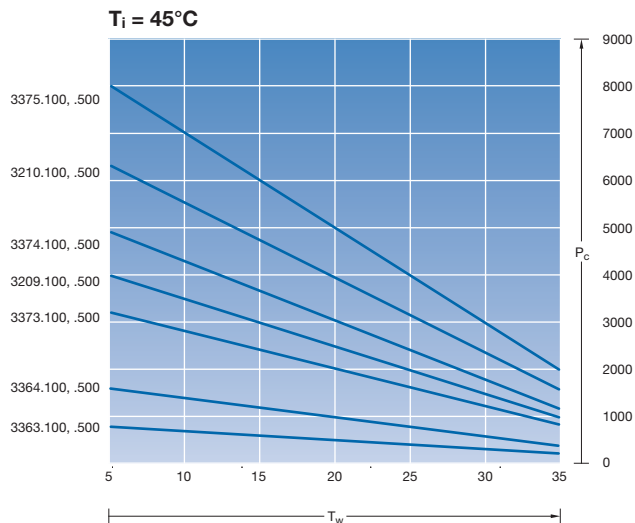
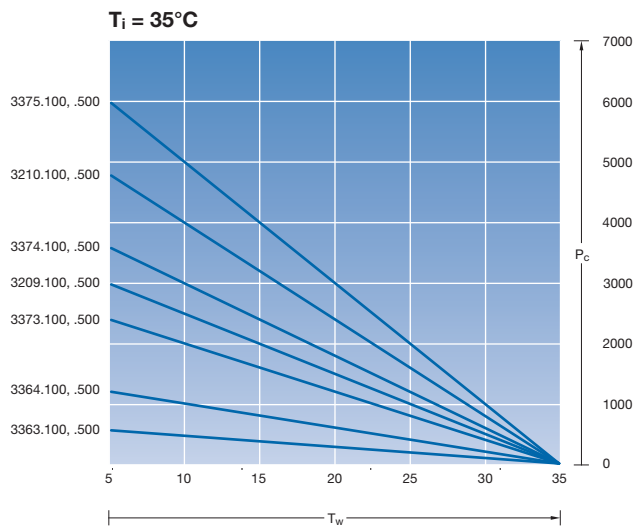
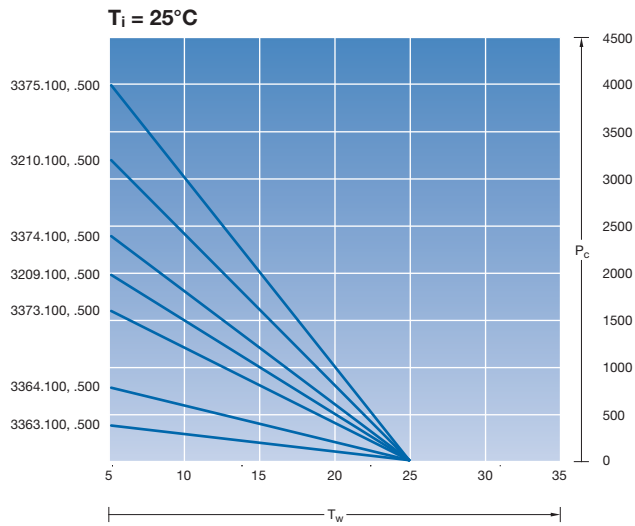

T_w = Water inlet temperature ($^\circ\text{C}$)
 P_c = Total cooling output (kW)
 T_i = Enclosure internal temperature ($^\circ\text{C}$)

**Output class 0.95 – 4.5 kW,
50 Hz, wall-mounted/roof-mounted**
Water-carrying parts: Stainless steel (1.4571)
Volumetric flow: 400 l/h

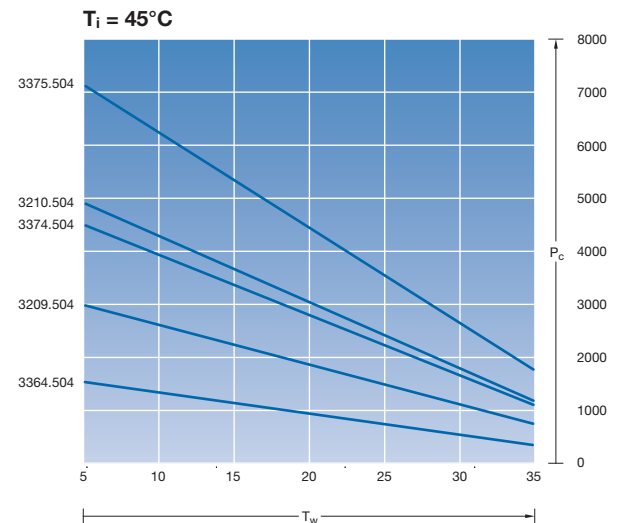
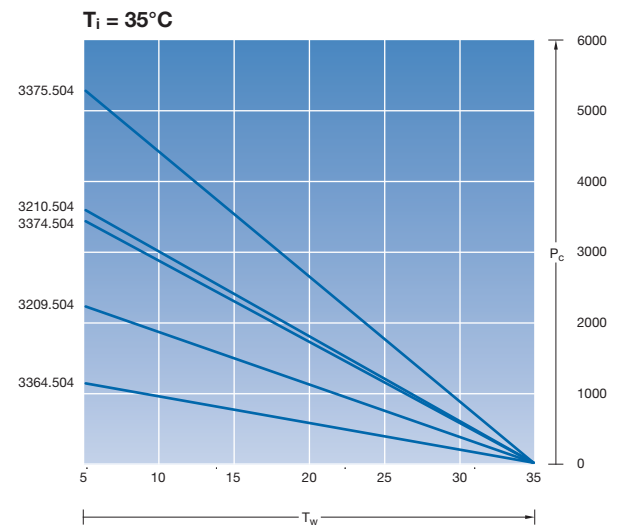
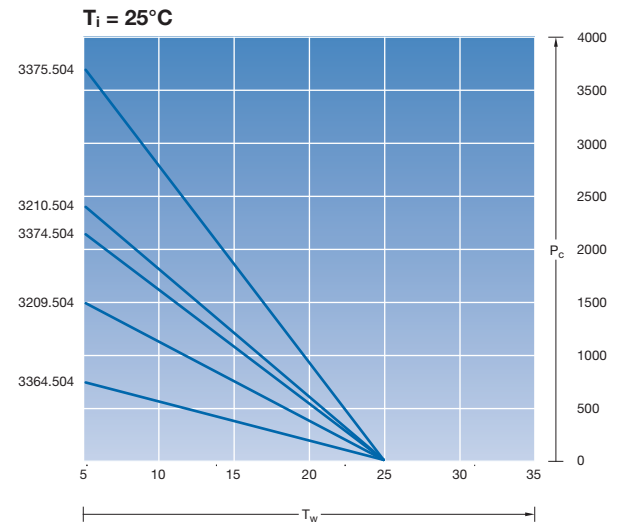

T_w = Water inlet temperature ($^\circ\text{C}$)
 P_c = Total cooling output (kW)
 T_i = Enclosure internal temperature ($^\circ\text{C}$)

Performance diagrams Air/water heat exchangers

**Output class 0.3 – 1.25 kW,
50/60 Hz, wall-mounted**
Water-carrying parts: Copper/brass (Cu/CuZn)

$T_i = 25^\circ\text{C}$

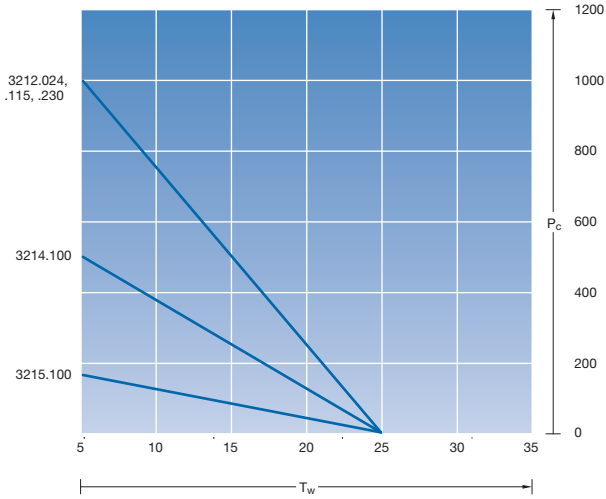

$T_i = 35^\circ\text{C}$

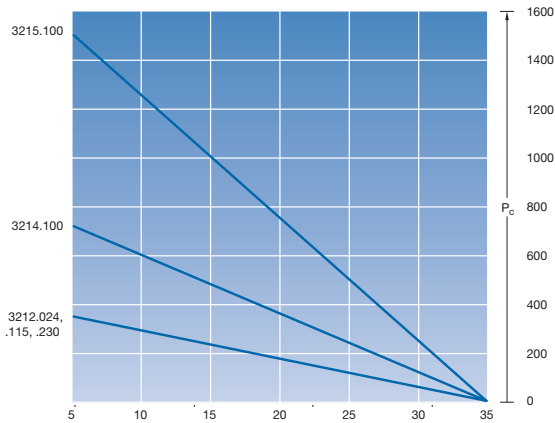

$T_i = 45^\circ\text{C}$

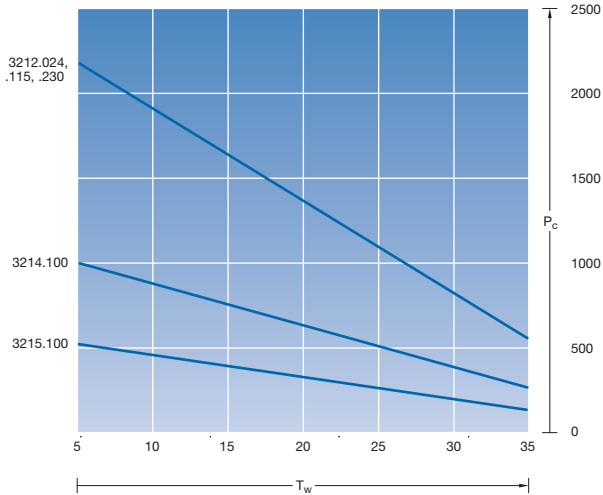

T_w = Water inlet temperature ($^\circ\text{C}$)
 P_c = Total cooling output (kW)
 T_i = Enclosure internal temperature ($^\circ\text{C}$)

**Output class 7 kW,
50/60 Hz, wall-mounted**
Water-carrying parts: Copper/brass (Cu/CuZn)

SK 3216.480

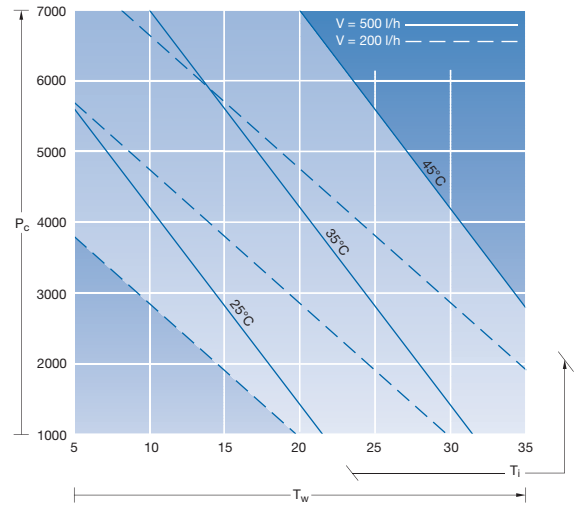

**Output class 10 kW,
50/60 Hz, LCP Rack Industry**
Water-carrying parts: Copper/brass (Cu/CuZn)

3378.200 280

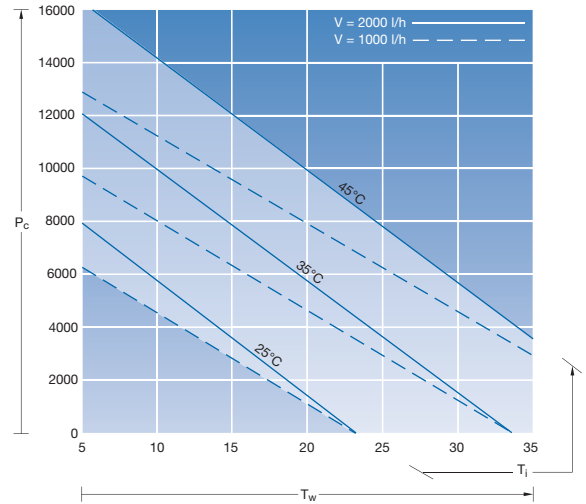

T_w = Water inlet temperature ($^\circ\text{C}$)
 P_c = Total cooling output (kW)
 T_i = Enclosure internal temperature ($^\circ\text{C}$)

Rittal – The System.

Faster – better – everywhere.



Catalogue

Our 2014/2015 Catalogue contains the latest order information for the entire Rittal product portfolio. We are sure you will find it clearly structured, with useful cross-references to matching accessories, alternative products and other important information.

Catalogue/websites

- Complete order information, structured according to your requirements
- Clear allocation of accessories
- Further information available on the Internet

Configure and design – Always “up-to-date”

Website – www.rittal.com

We have prepared Web pages and selectors/configurators for many of our products which summarise the benefits clearly and transparently, making it easier for you to select the right one. Take a look for yourself!

TopTherm chiller configurator

The TopTherm chiller configurator is a cost-effective way of designing your required machine and process cooling. Cooling output, volumetric flow and refrigerant temperatures are precisely tailored to your required application.

Therm software and app

The Therm software package takes care of the complex calculation of your climate control requirements. A user-friendly interface guides users to the most suitable, correctly dimensioned climate control component.

A quick version of the Therm software is available as a free app.

CFD (Computational Fluid Dynamics)

We offer customised 3D computer simulations to predict and visualise the thermodynamic response of the enclosure and cooling, for optimum design of your enclosure climate control.

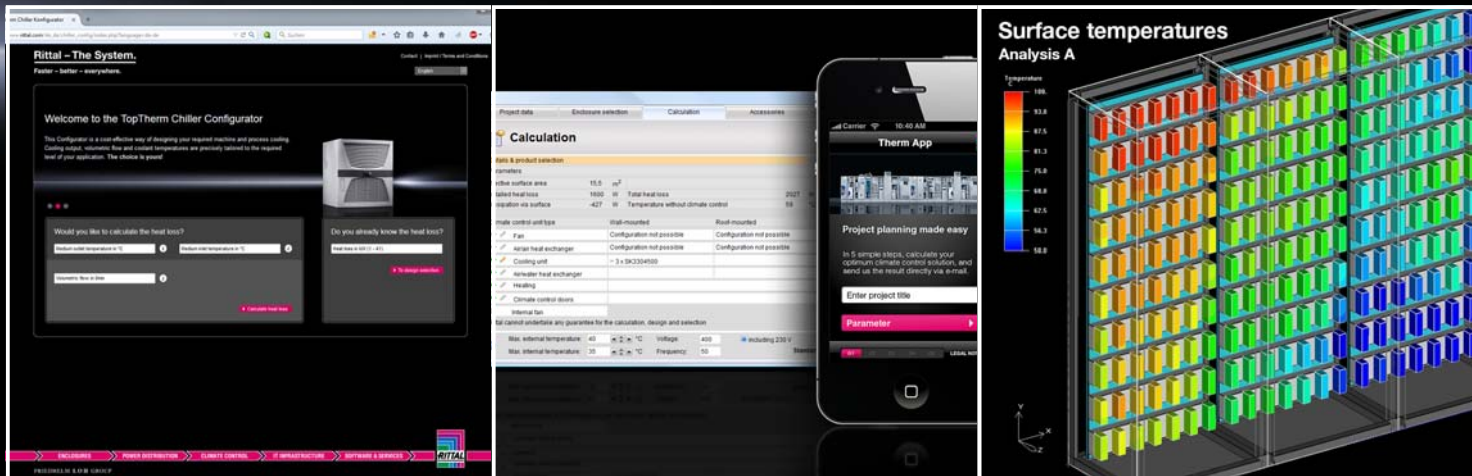

Selectors/configurators

- Calculate the heat loss, either mathematically or manually
- Comprehensive range of accessories
- Drawings downloadable in dwg, pdf, or 3D pdf format
- Downloadable specifications/tender texts
- Interactive performance diagram: Cooling output + pump capacity
- Add option packages and download bill of materials
- Transfer order list to shopping basket
- Send a quote request

Therm software/Therm app

- Improved user prompting using tabs and simple selection menus
- Configurator for recooling systems
- Heat loss calculator
- Fast calculation of required climate control measures

CFD (Computational Fluid Dynamics)

- Plan ahead
- Perfect dimensioning
- Planning confidence
- Comprehensive flow and heat analyses for forecasting

References



Customisation of standard products

Mechanical engineering trends are becoming increasingly design-led. Supfina Grieshaber uses enclosure system technology from Rittal to offer an interesting solution: the Planet V machine series. As one of the world's leading manufacturers of superfinishing and grinding machines, Supfina Grieshaber is committed to bringing even more compact, cost-effective machines onto the market, without compromising on precision, productivity and user-friendliness. The upgraded Planet V, launched in 2014, is a prime example. Standardisation is a core corporate philosophy.



“We use standard components to configure individual solutions. We are constantly striving to expand and improve our modular system”, explains Thomas Harter, product manager at Supfina Grieshaber.



Planet V also uses standard products from the “Rittal – The System.” range in its infrastructure components. Rittal is the machine manufacturer’s central supplier, offering everything from enclosure technology, to cooling technology, through to power supply. Unlike conventional machinery engineering concepts, at Planet V the electrical equipment is not housed inside the machine, but outside it, in a TS 8 standard enclosure suite adapted to suit the design. The “outsourced” and bayed enclosure infrastructure, which is linked to the machine via a track, comprises five TS 8 enclosures, an integral liquid-based cooling solution from the LCP Industry

series, a standardised recoler from the TopTherm chiller series, and the RiLine busbar system. “The outsourced enclosure system technology allows us to design individual machine layouts to suit the available space”, explains Thomas Harter, product manager at Supfina Grieshaber, adding, “By using integrated solutions that combine enclosure technology, cooling solutions and power distribution technology, we can be sure of 100% technical compatibility”.



“Developing a centralised climate infrastructure with water as the cooling medium was the only expedient solution for dissipating high heat loads completely from the enclosures”, says Andreas Geeb of Bosch Rexroth.



Stay cool with climate control

Extremely high enclosure temperatures are the norm in the industrial environment of a foundry. At Bosch Rexroth in Lohr, a recently installed climate control solution from Rittal creates constant temperatures while saving energy at the same time.

To avoid overheating, the company opted for a liquid-based cooling solution with TopTherm chillers and air/water heat exchangers from Rittal. Bosch Rexroth is collaborating with Rittal on an in-house standard for the space-saving, efficient cooling of enclosures.

The anti-heat stress system

In plant engineering, consistent standardisation and the use of systems engineering create maximum efficiency and reliability. A reference application at elotec Elektrotechnik GmbH, Mainhausen, on behalf of Volkswagen China, illustrates the efficient implementation and reliable operation of machinery to DIN EN 61 439 with heat loads of up to 20 kW, thanks to Rittal systems engineering.

The solution comprises the Ri4Power modular system, based on eight TS 8 enclosures with Maxi-PLS and Flat-PLS busbar systems and two air/water heat exchangers from the LCP Industry series, plus one TopTherm chiller. “This coordinated system range is enormously beneficial for us”, says Gerhard Becker, Managing Director of elotec, adding, “The modular standard components from Rittal, with their fast availability,

play a crucial role in our mission to provide efficient, reliable plant engineering to DIN EN 61 439”.



elotec



Service – Global availability

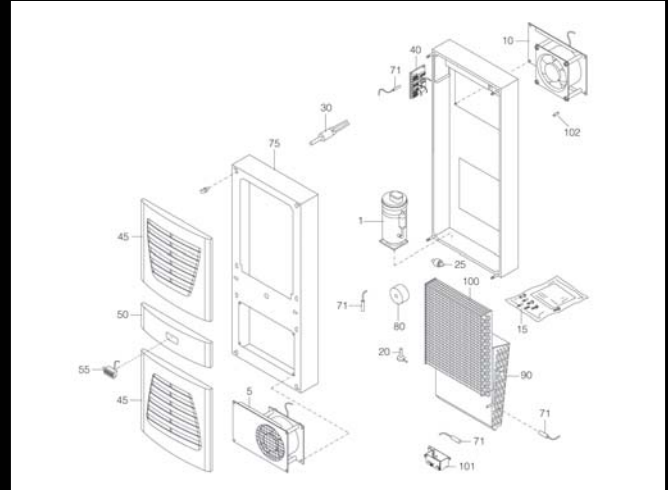
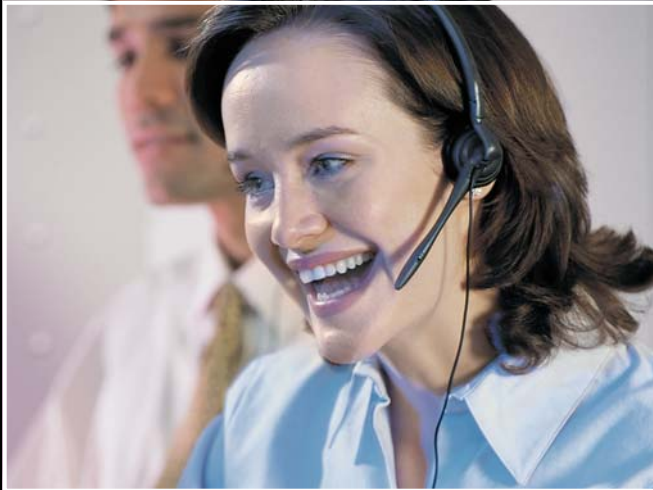

Your direct line to our service department

Whenever, wherever and however you need us, we are always on hand to assist you! Simply give us a call, send an e-mail or visit our website to get in touch. Fast, simple and reliable.

The benefits to you:

- International availability
- 24-hour service
- Communicate in your local language

Spare parts – original from the manufacturers

Simply select your product on our Website www.rittal.com/spare_parts and we will dispatch your spare part within 24 hours.

The benefits to you:

- Global stocking of standard spare parts
- 24-hour dispatch from our warehouse
- Approved original spare parts from the manufacturer

Rittal service addresses worldwide

Rittal Europe and Africa

✉ service@rittal.de
☎ +49(0)2772 505-1855

Rittal North and Central America (USA)

✉ service@rittal.us
☎ +1 800 477 4000 Option 3

Rittal South America (Brazil)

✉ service@rittal.com.br
☎ +55 11 36 22 23 77

Rittal Middle East (Dubai)

✉ service@rittal-middle-east.com
☎ +971 (4) 3416855 ext. 206

Rittal South-East Asia (Singapore)

✉ service@rittal.com.sg
☎ +65 6309 7327

Rittal Service Germany

Service Sales

✉ servicesales@rittal.de
☎ +49 (0)2772 505 1717

Factory repairs

✉ service@rittal.de
☎ +49 (0)2772 505 1855

Spare parts management

✉ serviceparts@rittal.de

Our service expertise gives you peace of mind. We therefore advise all customers and maintenance providers to take advantage of our services:

Assembly and installation

- We assemble and connect the products and systems in accordance with the statutory regulations.
- Maximum reliability from the outset

Pipework

- The right connection is important, so use our pipework service for water and/or refrigerant lines.

Commissioning

- We draw on our expertise as manufacturers commission your products and systems to ensure that they meet the assured properties.

Service agreements

- Preserve the value of your products and systems with individual service agreements.
- Our service modules are tailored to your requirements, to minimise potential downtime.

Extended warranty

- Cost transparency over a long period, thanks to a 5-year manufacturer's guarantee when you sign one of our modular service agreements.

Leak test

- We help you to meet the statutory requirements.
- F-Gas Regulation 517/2014 on the control of greenhouse gases

Rittal – The System.

Faster – better – everywhere.

- Enclosures
- Power Distribution
- Climate Control
- IT Infrastructure
- Software & Services

You can find the contact details of all Rittal companies throughout the world here.



www.rittal.com/contact

XWWW00025ENT1611



FRIEDHELM LOH GROUP